

【金蔵山古墳出土埴形埴輪】

1

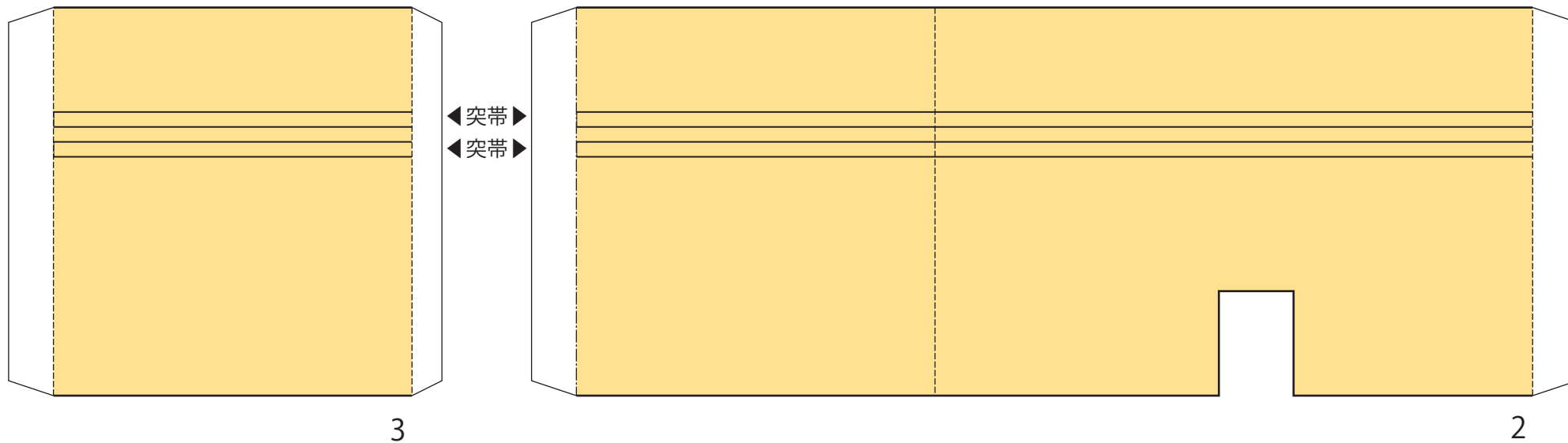

【金蔵山古墳出土冢形埴輪】

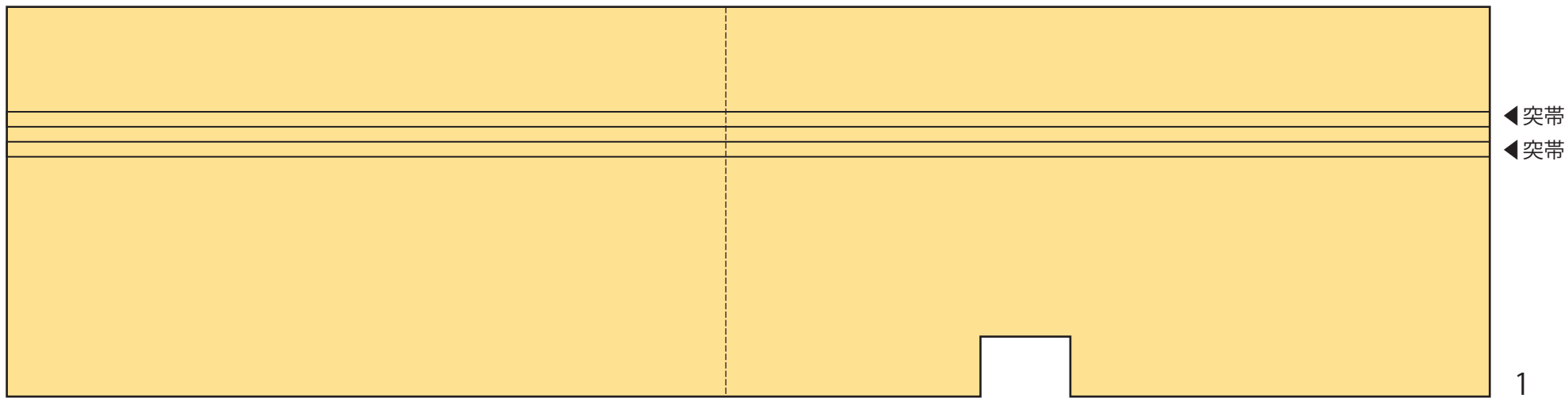
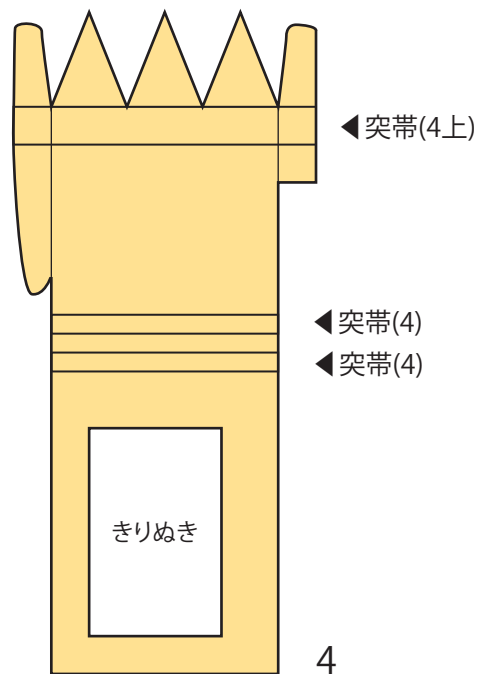
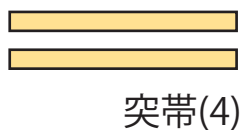
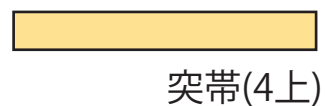
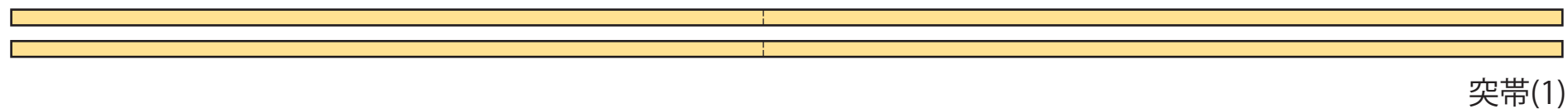

つくりかた【冢形埴輪】

1～4をつなぎあわせます。

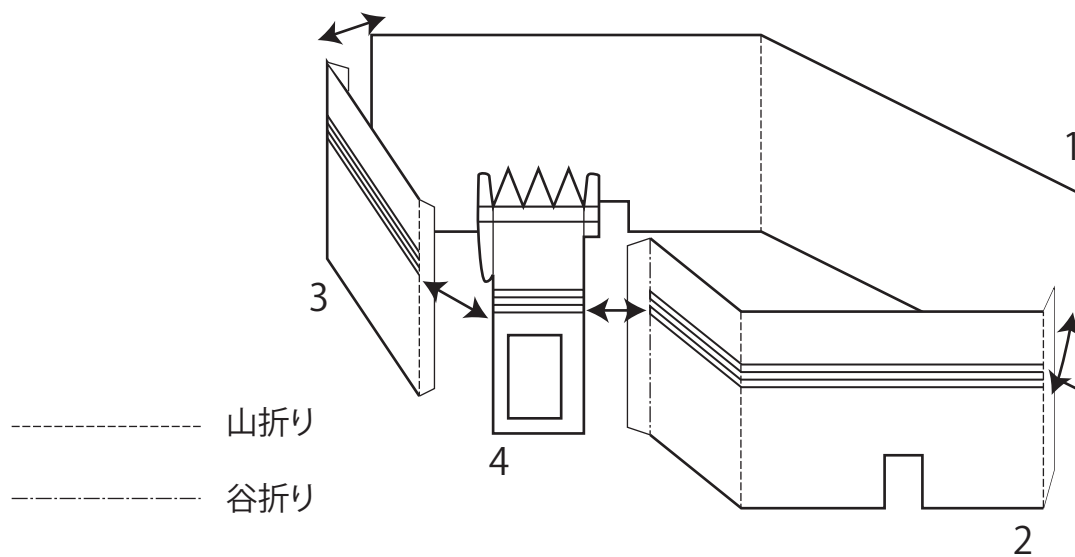

★お好みで突帯をはりつけましょう。

★建物形(導水施設)埴輪と同じ縮尺(1/4)です。中に入れて飾りましょう。